

# "Pocket" Sized Soft Starter SST Series

## Selection Guide

Built-in bypass

Top brand component

Alloy high intensity body

Control unit & Internal power supply design

Free of setting, fast arranging

"Pocket Size" body



# SAFESAVE

### By Industry

- Textile
- Mixer
- Conveyor
- Air compressor
- Extrusion machine
- Food process machine
- Fan
- Etc.

## SAFESAVE

Zhejiang Saikong Electrical Technology Co., Ltd

Nationwide hotline: +86 0577 61768877

Address: #22 Liujiang Avenue, Liushi Town, Yueqing City,  
Zhejiang Province, China

Website: [www.safeinvert.com](http://www.safeinvert.com)

Skype/Whatsapp/Wechat: +86-13373857120

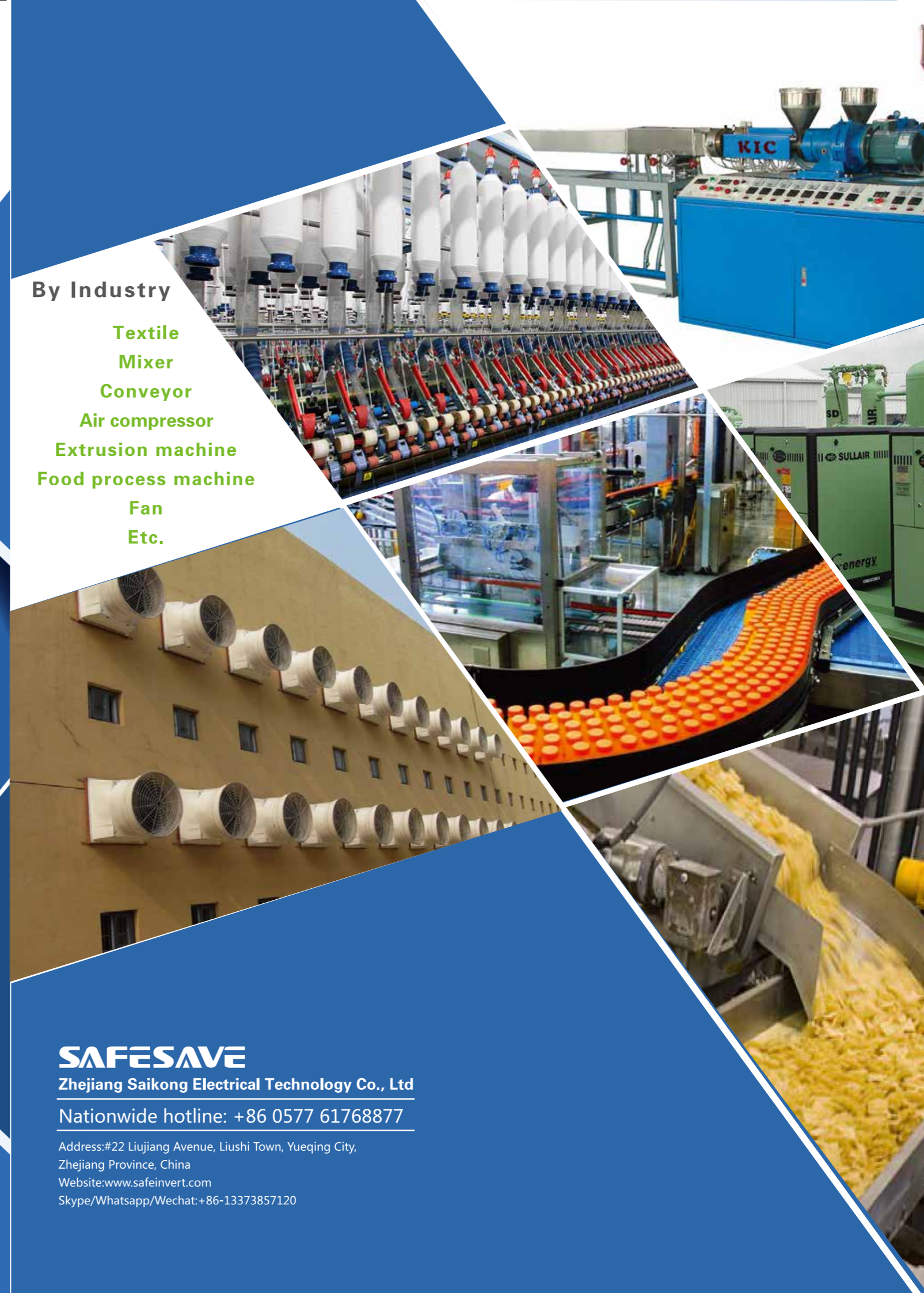

## Product dimensions

(Unit: mm)

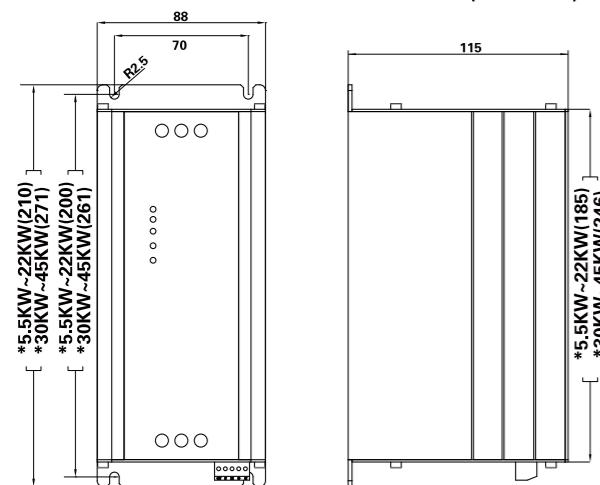

## Installation sketch

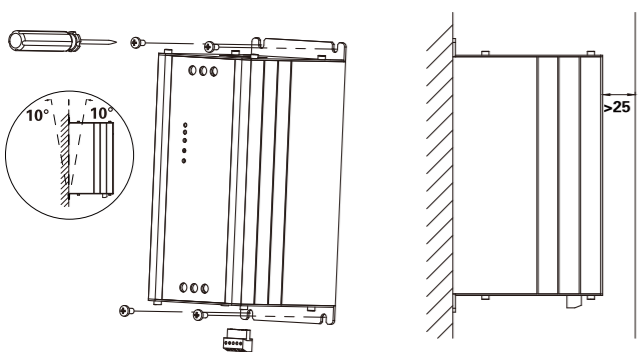

## Operation sequence diagram

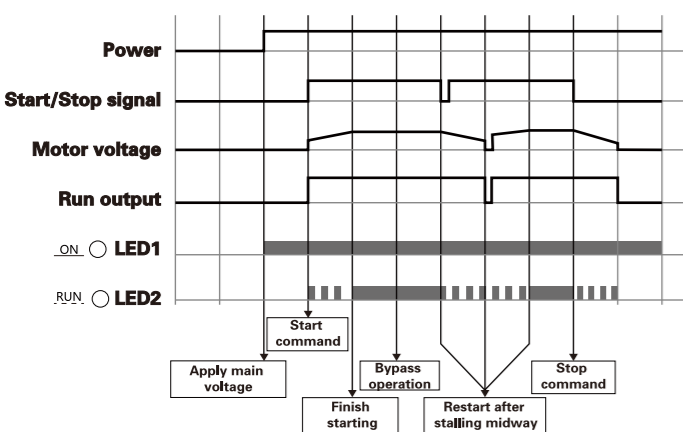

## Indicator light

Indicator light			
Run/On	Steady lighting	Flashing	Off
Steady lighting	Bypass operation	Input/output phase loss	Hardware failure
		Hardware failure	
Flashing	Soft start/soft stop in progress	Hardware failure	Hardware failure
		Hardware failure	
Off	The device is ready for power on	Input/output phase loss	Soft start power failure or indicator light failure
		No motor connected	

## Terminal description

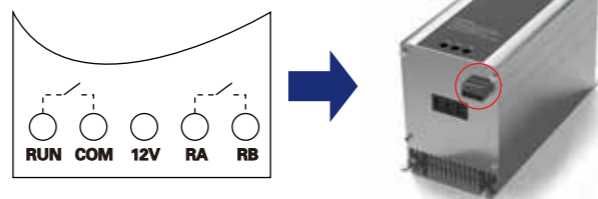

## Major Loop

Terminal marking	Terminal name	Function description
L1, L2, L3	Mains input of major loop	Connect three-phase source
T1, T2, T3	Output connection of soft start	Connect three-phase motor

## Control Loop

Terminal marking	Terminal name	Function description
RUN	Enable input	When closing run and com, start to operate. When breaking run and com, motor slows down and halts.
COM	Common port	run and common port at 12V
12V	Power terminal	Interior power output terminal at 12V, 300mA at maximum, prohibit overload.
RA, RB	Indication of working status	Working status: relay output, normally open contact, close during operation, break if stall or fault, relay capacity 250V/AC 0.3A.

## Power diagram

Model	230V/KW	400V/KW	500V/KW	Rated current A
SST-5R5	3	5.5	5.5	13
SST-7R5	4	7.5	7.5	17
SST-11	5.5	11	11	25
SST-15	7.5	15	15	32
SST-18	7.5	18.5	22	37
SST-22	11	22	30	45
SST-30	15	30	37	60
SST-37	18.5	37	45	75
SST-45	22	45	55	90

## Wiring Parameter

Model	Rated power	Main Circuit Diameter	Main Circuit Tightening Torque	Control Circuit Diameter	Tightening Torque Control Circuit
	KW	GB Copper Core(mm <sup>2</sup> )	Lbf/inch	(mm <sup>2</sup> )	Lbf/inch
SST-5R5	5.5	2.5	10.6~13	0.64~1	2~2.2
SST-7R5	7.5	2.5	10.6~13	0.64~1	2~2.2
SST-11	11	4	10.6~13	0.64~1	2~2.2
SST-15	15	6	10.6~13	0.64~1	2~2.2
SST-18	18.5	10	10.6~13	0.64~1	2~2.2
SST-22	22	10	10.6~13	0.64~1	2~2.2
SST-30	30	16	18~22	0.64~1	2~2.2
SST-37	37	25	18~22	0.64~1	2~2.2
SST-45	45	35	18~22	0.64~1	2~2.2

## Parameter setting

### Panel parameters

**Knob of soft starting time:** adjust soft starting time of soft starter and range is 1~20S. The longer the time setting, the more gentle the soft starting process, which is helpful to reduce the impact on power grid.

**Knob of soft stopping time:** adjust soft stopping time of soft starter and range is 0~20S. In some application occasions of water pump, soft stopping function can effectively avoid "water hammer effect" generated by the halt of water pump. When the knob is adjusted to be 0S, it indicates that the stalling way of motor is free stalling, which will stop output immediately after soft starting.

**Knob of initial voltage:** adjust initial voltage of soft starter and range is 40%~70%. When the motor starts, it needs to overcome the friction under stationary state. Properly increasing the initial voltage can obtain larger starting torque. The users should refer to actual load condition to coordinate starting and stopping time, thus obtaining the best effect of smooth starting.

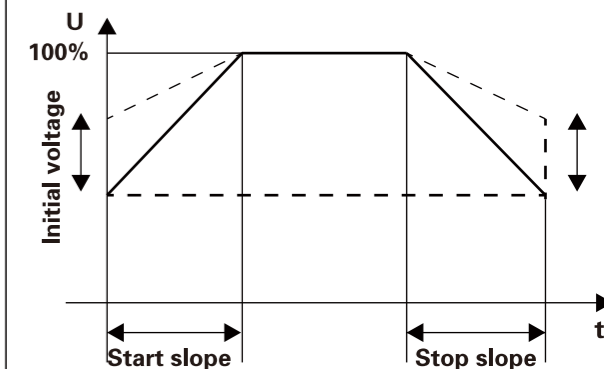
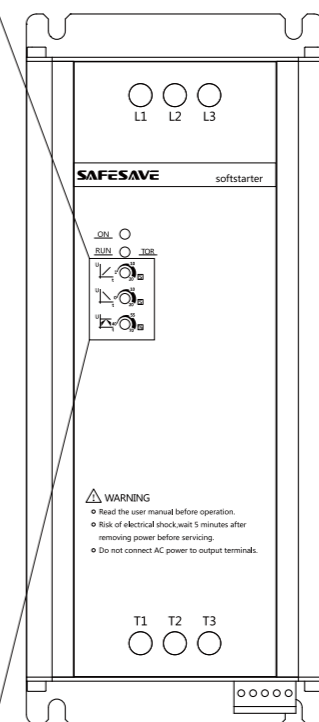

## Wiring diagram

